

Uniden®

Cordless Telephone

EXAI 7980

Owner's Manual

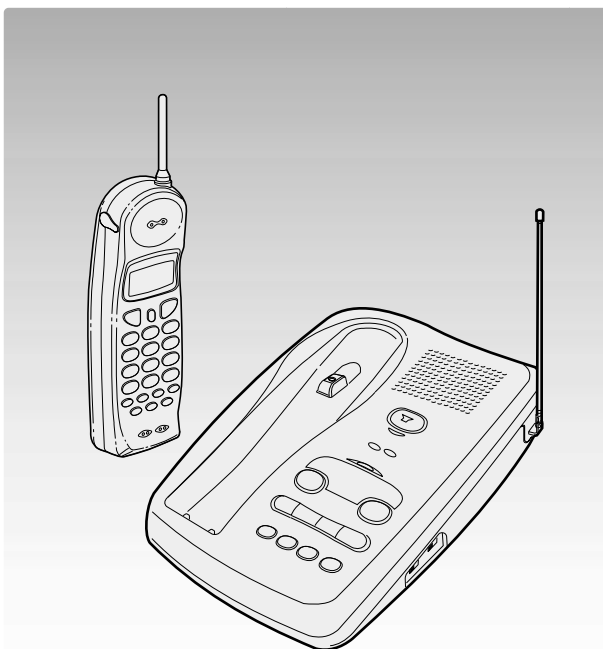

Thank you for your purchase of the Uniden EXAI 7980 cordless telephone. Please read this Owner's Manual carefully before using your cordless telephone to ensure proper use. After reading the manual, please keep it in a safe place and refer to it when necessary.

©2000 Uniden America Corporation

Introduction

Thank you for choosing the Uniden EXAI 7980 cordless telephone. This phone is designed to exacting standards that provide reliability, long life and outstanding performance.

Note: Some illustrations in this manual may differ from the actual unit for explanation purposes.

Features

- 900 MHz Technology
- 3-line Backlit Display
- Face Up/Face Down Charging
- 32 Digit Redial
- Page/Find
- Handset Earpiece and Ringer Volume Control
- 15 minutes Record Memory
- Conversation Record and Voice Memo
- Call Waiting Caller ID
- 30 Number Caller ID Memory
- 10 Memory Dial Locations
- Pulse / Tone Dialing
- 7 Hour Talk Time
- Remote Message Retrieval
- Prerecorded Greetings Option
- Hearing Aid Compatible

The EXAI 7980 features include AutoTalk and AutoStandby. AutoTalk allows you to answer a call by just removing the handset from the base so you don't have to waste time pushing buttons. AutoStandby allows you to hang up by simply returning the handset to the base.

The **UltraClear Plus** true compander circuitry virtually eliminates background noise. This innovative technology, together with 40 different channels, provides you with the best possible reception during all your conversations.

To protect you against misbilled calls which might result from your phone being activated by other equipment, the EXAI 7980 has **Random Code™** digital security which automatically selects one of over 65,000 digital security codes for the handset and base. Also, the **AutoSecure™** feature electronically locks your phone when the handset is on the base.

To get the most from your phone, please read this owner's manual thoroughly. Also, be sure to complete and mail the product registration form.

Be sure to visit our web site at: www.uniden.com.

Table of contents

Getting Started

Read this first	4
Step 1: Checking the package contents	5
Step 2: Setting up the base unit	6
Step 3: Preparing the battery pack	9
Step 4: Setting Caller ID options	11
Entering your area code	12

Basics

Making calls	13
Dialing from standby	13
Dialing from talk mode	14
Redialing	15
Receiving calls	16
Receiving a call from the handset	16
Receiving a call from the base	18

Telephone Features

Storing phone numbers and names	19
Making calls with memory dialing	21
Editing a stored name and/or phone number	23
Erasing a stored name and/or phone number	25
Using the Page Feature	26

Caller ID Features

When the telephone rings	27
Viewing the Caller ID message list	28
Deleting information from the Caller ID list	29
Using the Caller ID list	31
Calling a party from the Caller ID list	31
Storing Caller ID messages in Memory	32
Using "Caller ID with call waiting" service	33

Using the answering machine

Setting the clock	34
Recording the greeting	35
Changing the greeting	35
Turning the answering machine on and off	36
Setting the number of rings	36
Setting maximum recording time for incoming messages	37
Playing recorded messages	38
Deleting recorded messages	39
Screening incoming calls	39
Leaving a voice memo	40
Recording a phone conversation (2-way REC)	41
Selecting a PIN code	42
Remote access away from home	43
Remote room monitor	44
Turn on the answering machine remotely	44

Additional Information

3-way conversation	45
Changing the digital security code	46
Mounting the base unit on a wall	47
Installing the beltclip	49
Headset installation	49
Note on power sources	50
Maintenance	50
Troubleshooting	51
Index	54

Getting Started

Basics

Telephone
Features

Caller ID
Features

Using the
Answering
Machine

Additional
Information

Read this first

This cordless telephone must be set up before use. Follow these steps;

Step 1 (page 5)

Unpack the telephone and accessories.

Step 2 (page 6 to 8)

Next, choose the best location to set up the base unit.



Base unit

Step 3 (page 9 to 10)

Then, insert the battery pack into the handset. You have to charge the battery pack for 12-15 hours before using the phone.



Handset

Step 4 (page 11 to 12)

Finally, set Caller ID options and store your area code in the memory to use the Caller ID service.

Note: Skip the setting of area code if your calling area requires 10 digits dialing.



Handset

About the digital security code

This cordless telephone uses a digital security code to prevent unauthorized access to your base unit. This security code prevents other cordless handsets from making calls through your base unit.

A random security code will be assigned automatically between your base unit and handset when you charge the battery pack for the first time.

To reset the security code, see page 46.

Step 1

Checking the package contents

Make sure you have received the following items in the package.
If any of these items are missing or damaged, contact the **Uniden Parts Department** (see below).

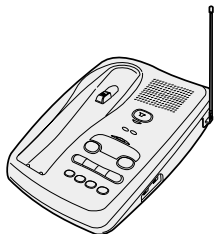

• Base unit



• Handset

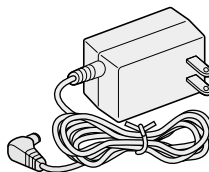

• AC adapter (AD-420)

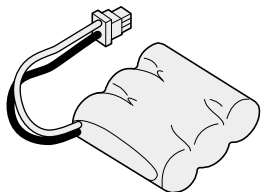

• Rechargeable battery pack (BT-905)

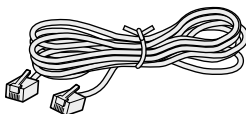

• Telephone line cord

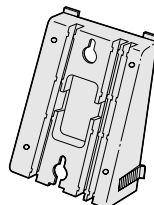

• Wall mount adapter

- This Owner's Manual
- Precautions and Important Safety Instructions
- Registration Card

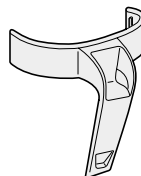

• Beltclip

Uniden Parts Department

(800) 554-3988

Hours are 7:00 a.m. to 5:00 p.m. Central Time, Monday through Friday.

We can also be reached on the web at www.uniden.com.

Step 2

Setting up the base unit

Do the following steps.

- Choose the best location
- Connect the base unit
- Choose the dialing mode

Choose the best location

Before choosing a location for your new phone, read the **INSTALLATION CONSIDERATIONS** included in the **PRECAUTIONS AND IMPORTANT SAFETY INSTRUCTIONS** brochure. Here are some important guidelines you should consider:

Avoid heat sources such as radiators, air ducts, and sunlight

Avoid television sets and other electronic equipment

Avoid noise sources such as a window by a street with heavy traffic

Avoid microwave ovens

Avoid excessive moisture, extremely low temperatures, dust, mechanical vibration, or shock

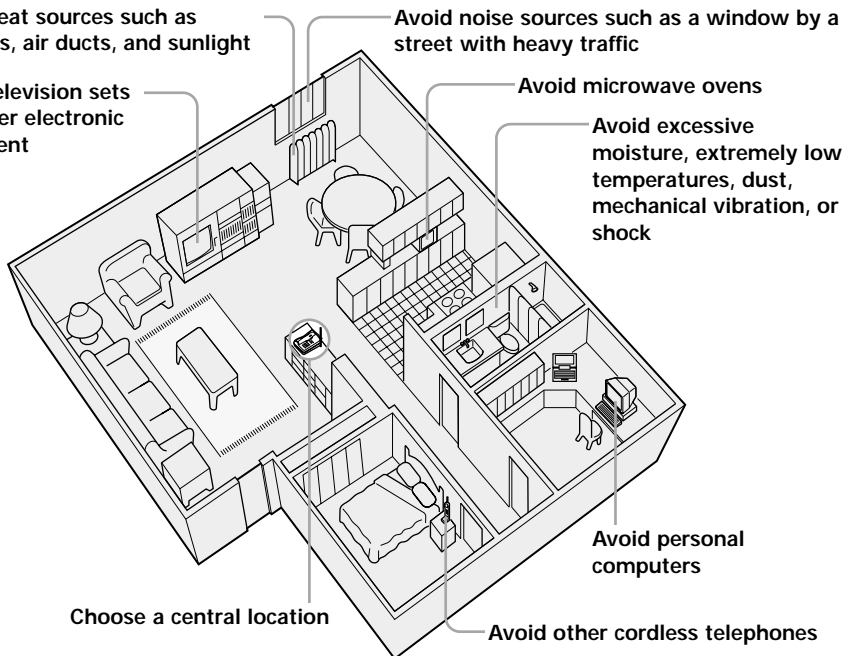

- You should charge your handset for 12-15 hours before using the phone.
- The location should be close to both a phone jack and a continuous power outlet which is not switchable.
- Keep the base and handset away from sources of electrical noise such as motors and fluorescent lighting.
- Be sure there is sufficient space to raise the base antenna fully vertical.
- The base can be placed on a desk, table top, or mounted on the wall.

Step 2 (continued)

Connect the base unit

If you want to install the base unit on the wall, see page 47.

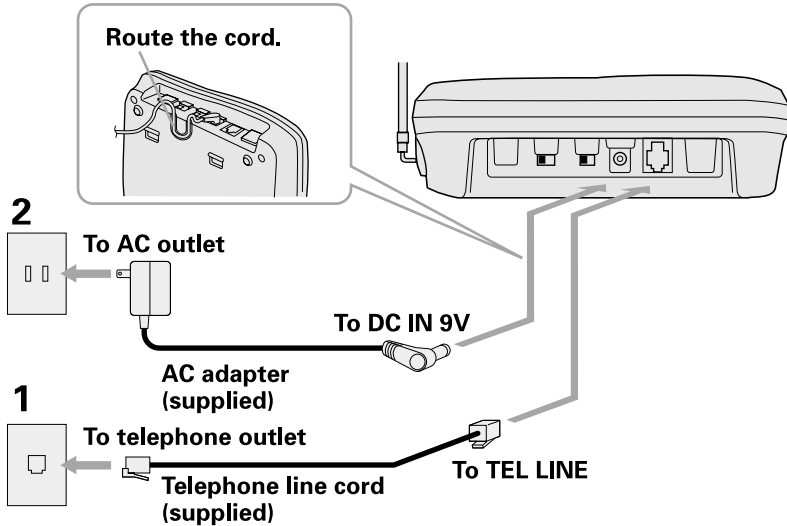

- 1 Connect the telephone line cord to the **TEL LINE** jack and to a telephone outlet.

Note Until the handset battery is fully charged, you can only answer incoming calls at the base unit.

- 2 Connect the AC adapter to the **DC IN 9V** jack and to a standard 120VAC wall outlet.

- 3 Set the base unit on a desk or tabletop and place the handset on the base unit. Then raise the antenna to a vertical position.

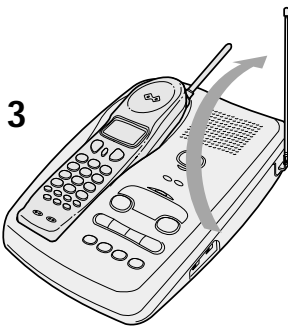

Note

Place the power cord where it will not create a trip hazard, or where it could become chafed and create a fire or electrical hazard.

Step 2 (continued)

Notes

- Use only the supplied AD-420 AC adapter. Do not use any other AC adapter.
- Place the base unit close to the AC outlet so that you can unplug the AC adapter easily.

Polarity of the plug

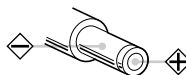

Tips

- If your telephone outlet isn't modular, contact your telephone company for assistance.

Modular



Choose the dialing mode

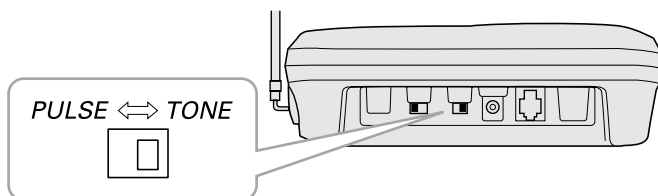

Depending on your dialing system, set the TONE/PULSE switch as follows:

If your dialing system is	Set the switch to
Tone	TONE
Pulse	PULSE

If you aren't sure of your dialing system

Make a trial call with the TONE/PULSE switch set to TONE.

If the call connects, leave the switch as is; otherwise, set to PULSE.

Step 3

Preparing the battery pack

Charge the battery pack for 12-15 hours before connecting the phone line.

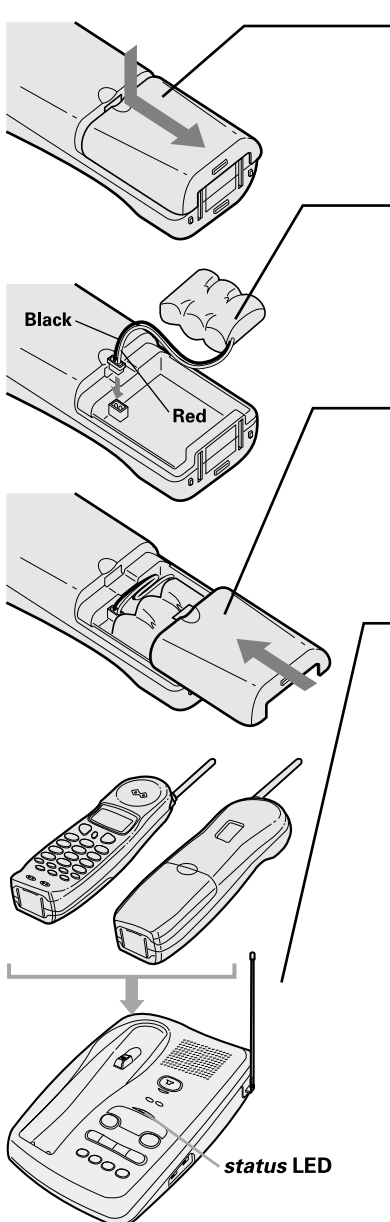

1 Press and slide the battery compartment cover toward the bottom of the unit.

2 Connect the battery pack connector with the correct polarity (black and red wires), then insert the battery pack into the battery compartment.

3 Securely close the battery compartment cover by sliding it up until it snaps into place.

4 Place the handset on the base unit with the keys and display facing upward. This position lets you see Caller ID messages on the display.

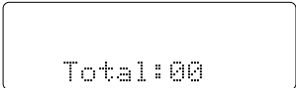

Total:00

When the handset has been properly placed on the charging terminals of the base unit, the "**status**" LED of the base unit lights and charging begins. Charge the battery for 12-15 hours. You can place either side up for charging the battery.

status LED

Step 3 (continued)

Battery use time (per charge)

From fully charged

- Seven hours continuous use.
- Seven days when the handset is in the standby mode.

When the battery charge becomes low

When the voltage of battery pack is very low and needs to be charged, the phone eliminates functions to save power. If the phone is not in use,

"Low Battery" flashes and none of the keys

will operate. If the phone is in use, "Low Battery" flashes and the handset beeps. Complete your conversation as quickly as possible and return the handset to the base unit for charging.

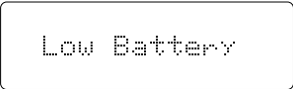

Low Battery

Notes

- Even when the battery pack is not being used, it will gradually discharge over a long period. For optimum performance, be sure to return the handset to the base unit after a telephone call for charging the battery.
- The built-in memory backup holds numbers and names stored in the memory for up to 2 minutes, while you replace the battery pack.

Cleaning the battery contacts

To maintain a good charge, it is important to clean all battery contacts on the handset and base unit with a dry cloth or pencil eraser, if necessary, about once a month.

Do not use any liquids or solvents.

Step 4

Setting Caller ID options

There are three Caller ID options, Auto Talk, CIDCW (Caller ID with Call Waiting), and Area Code.

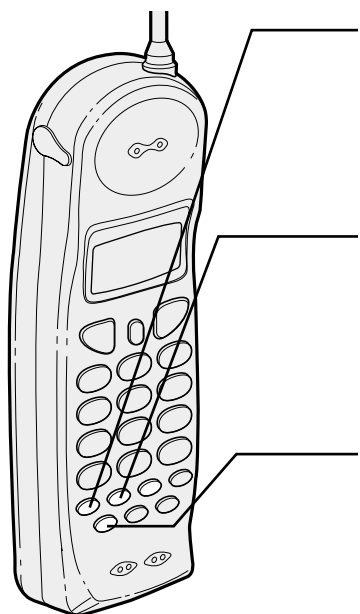

- 1** In the standby mode, press and hold **call id** until a tone sounds and the Caller ID option screen appears.

```
1 Auto Talk: Off
2 CIDCW      : On
3 Area Code:
```

- 2** Press **▲ up** or **▼ dn** to move the pointer to the item that is to be set.

Example: To select CIDCW

```
1 Auto Talk: Off
2 CIDCW      : On
3 Area Code:
```

- 3** For Auto Talk and CIDCW press **select** to toggle between on and off. For the Area Code setting please see page 12.

- 4** To complete the settings, press **call id**, then the handset returns to standby mode.

Notes

- The AutoTalk feature provides a quick and easy way to answer calls. If the phone rings with AutoTalk set to on, simply remove the handset from the cradle. If the handset is off the base, simply press any key.
- With the AutoTalk feature turned off, this eliminates accidental call intrusion. If someone else is on the line with another phone, they will not be disturbed if you simply pick up this handset from the cradle to view the Caller ID display.

Step 4 (continued)

Entering your area code

Note Skip this step if your calling area requires 10 digit dialing.

When you use this phone for the first time, or move to an area that has a different area code, you must enter your area code. This is necessary because the phone must distinguish local or long distance calls to properly dial calls from the Caller ID message list. (See page 31.)

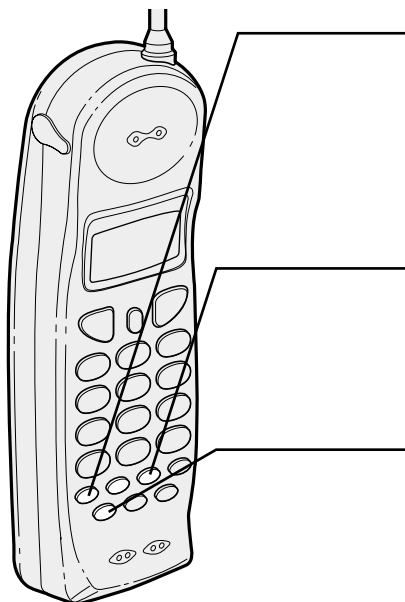

- 1** In the standby mode, press and hold **(call id)** until a tone sounds and the Caller ID option screen appears.

```
1# Auto Talk: Off
2 CIDCW      : On
3 Area Code:  
```

- 2** Press **(▲ up)** or **(▼ dn)** to select "Area Code".

```
1 Auto Talk: Off
2 CIDCW      : On
3# Area Code:  
```

- 3** Press **(select)**.

```
1 Auto Talk: Off
2 CIDCW      : On
3 Area Code: █
```

- 4** Use the number keypad (**(0)** to **(9)**) to enter the 3-digit area code.

- 5** Press **(select)**.

A tone sounds and the displayed area code is entered.

- 6** Press **(call id)** or return the handset to the base unit to complete the setting mode. The handset returns to the standby mode.

Note

When the area code has already been stored in memory, the stored area code will be displayed. To change it, use the number keypad to enter the new area code.

```
1 Auto Talk: Off
2 CIDCW      : On
3 Area Code: 81█
```

To delete the area code, press and hold **(delete)** until the stored number is removed from the display. Then press **(select)**.

To complete the setting, press **(call id)** or return the handset to the base unit.

Making calls

Dialing from standby



- 1 Dial the phone number.
(up to 32 digits.)

Example: Enter 817-858-3300

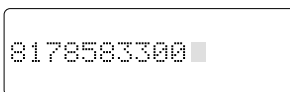

- 2 Press **(talk)**. "Talk" flashes on the display. Then the volume setting appears for a few seconds.

Example: Volume level "High"



- 3 The number is dialed. After about 5 seconds, the call-time display appears.

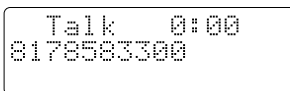

- 4 To hang up, press **(talk)** or place the handset on the base. The call-time will be displayed for about 5 seconds.

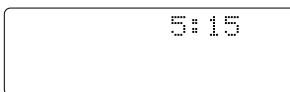

Other Operations

To	Do this
To improve reception	Press (chan) .
To adjust the earpiece volume	Press (▲ up) or (dn ▼) .
To temporarily switch to tone dial (When the the base is set to pulse mode)	Press (*/tone/◀) . The following numbers dialed will be sent as tone dialing.
To enter a pause in the dialing sequence	Press (redial/p) .

Dialing from talk mode

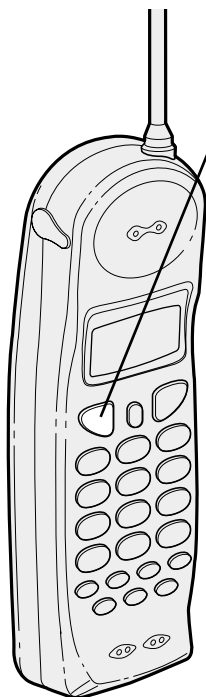

- 1 Pick up the handset.
- 2 Press **talk** "Talk" and the volume setting appear on the display.



- 3 Dial the phone number.
After about 5 seconds, the call-time display appears.

Example: Enter 817-858-3300

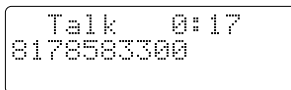

- 4 To hang up, press **talk** or place the handset on the base. The call-time will be displayed for about 5 seconds. The phone returns to standby.

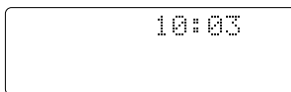

Redialing

The redial key redials the last number dialed. The redialed number can be up to 32 digits long.

Redialing from standby

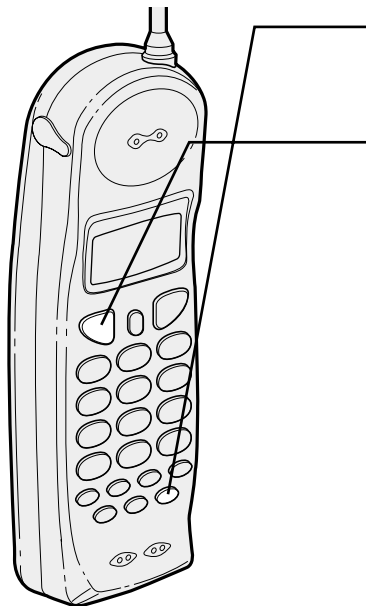

- 1** Press **(redial/p)**.
The phone number that was last dialed appears on the display.
- 2** Press **(talk)**. "Talk" and the volume setting appear on the display.
- 4** Then the phone number is dialed.
After about 5 seconds, the call-time display appears.
- 5** Press **(talk)** or place the handset on the base to end the telephone call.
The call-time will be displayed for about 5 seconds.

Note

If the recently dialed number exceeds 32 digits, only the first 32 digits are retained for redialing.

Redialing from the talk mode

- 1** Press **(talk)**.
"Talk" appears flashing on the display.
- 2** Press **(redial/p)**.
- 3** Press **(talk)** or place the handset on the base to end the telephone call. The call-time will be displayed for about 5 seconds.



Receiving calls

Receiving a call from the handset

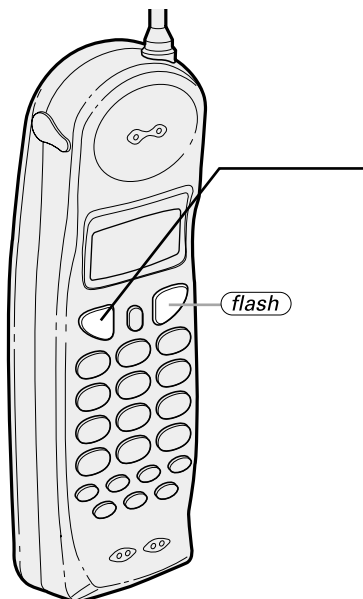

1 Phone rings.

Incoming Call

2 Press **(talk)**. "Talk" and the volume setting appear on the display.

Talk
<High>

3 To hang up, press **(talk)** or place the handset on the base. The call time will be displayed for about 5 seconds.

1:15:35

Auto Talk when ringing

When the Auto Talk setting is on and there is an incoming call, simply lift the handset from the base unit to answer the phone.

Any key when ringing

When the Auto Talk setting is on and the handset is off the base, press any handset key to answer the incoming call.

Call Waiting

Note: You must subscribe to Call Waiting service to use this feature.

When a call is received during a telephone call already in progress, press **(flash)** to switch to the new call. If you also subscribe to Caller ID on call waiting, you will see the name and number of the caller in call waiting (See page 33.)

Note

AutoTalk is initially set to off as the default setting.

To turn it on, proceed to setting Caller ID options. (See page 11.)

Receiving calls (continued)

Handset ringer tone

In the standby mode, press **▲ up** or **dn ▼**.
Each time **▲ up** or **dn ▼** is pressed, the ringer tone setting changes and the selected ringer tone sounds for 2 seconds.

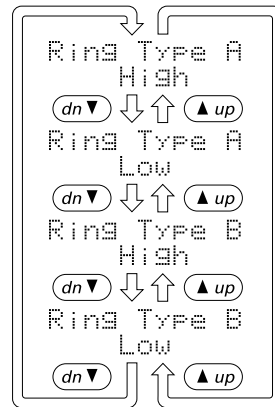

Handset earpiece volume

During a telephone call, pressing **▲ up** or **dn ▼** will change the earpiece volume of the handset. This setting will remain in effect after the telephone call has ended.

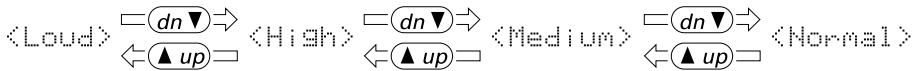

When you press **▲ up** in Loud mode or press **dn ▼** in Normal mode, an error tone sounds.

Receiving a call from the base

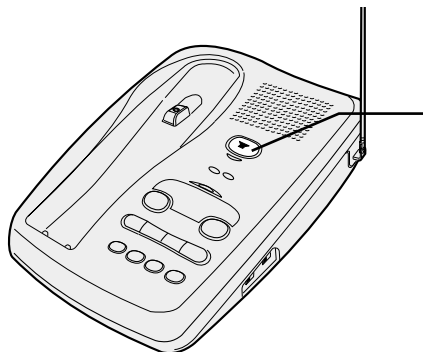

- 1** The base rings. The **status** LED on the base flashes.
- 2** Press **speaker** and speak.
- 3** When you finish the call, press **speaker** to hang up.

Base ringer switch

To turn off the ringer, set the ringer switch to the off position. This switch turns the base ringer on or off.

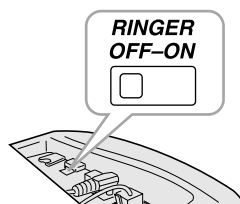

Base speaker volume

To control the speaker volume of the base, adjust the **volume ▲** and **volume ▼** button as desired.

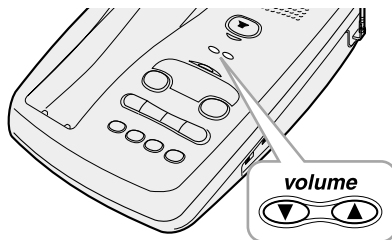

Memory storing

You can store up to 10 phone numbers in the dial memory.

Storing phone numbers and names

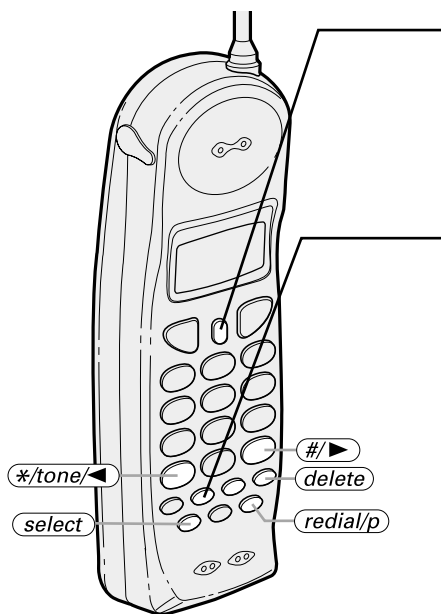

- 1** Press and hold **(mem)** until a tone sounds and "Memory Store" is displayed.

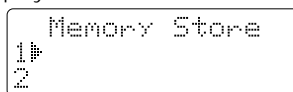

- 2** Press **(▲ up)** or **(▼ dn)** to scroll to the memory location where you would like to store the number.

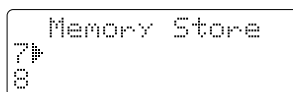

Or press the keypad (**0** to **9**) to select the memory location where you would like to store the number.

- 3** Press **(select)**.
When an empty memory location is selected, "Store Name" is displayed. The cursor flashes indicating that the display is ready for the name to be entered.

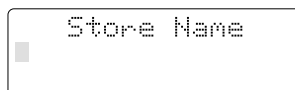

If this screen appears, the memory location is full. You must edit the location. (See page 23.)

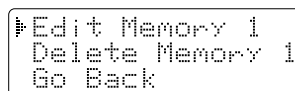

Note

Whenever you are using a menu screen, you must press a key within 20 seconds or the phone will return to standby. If you return the handset in the cradle, the phone will return to standby too.

Memory storing (continued)

- 4 Use the **▲ up**, **dn ▼**, **#/▶**, ***/tone/◀**, or **delete** keys to enter the name. The name cannot exceed 16 characters.
- Use the **▲ up** and **dn ▼** key to scroll through the characters.
 - Use the **#/▶** and ***/tone/◀** to move the cursor to the desired position.
 - Use the **delete** key to delete characters as needed.

- 5 Press **select**.
"Store Number" is displayed. The cursor flashes indicating that the display is ready for the number to be entered.

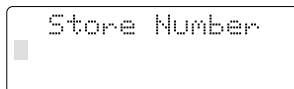

Store Number

- 6 Use the keypad, ***/tone/◀**, **#/▶**, or **redial/p** keys to enter the phone number. The phone number can be up to 16 digits.
- Use the **redial/p** key to enter pause in the dialing sequence. The display shows a "P".

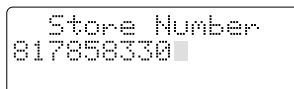

Store Number
817858330

Note The pause feature is useful for long distance calling, credit card dialing, or sequences that require a pause between digits.

- Use the **delete** key to delete digits needed.

- 7 Press **select**.
The handset beeps and displays the confirmation screen. Memory storage is complete.

For example if you store a name and number into memory location number 7, the display shows "Memory 7 Stored".

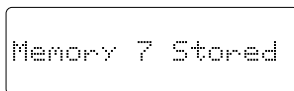

Memory 7 Stored

After about 2 seconds, "Memory Store" is displayed.

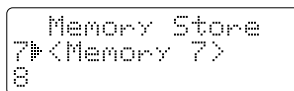

Memory Store
7<Memory 7>

Memory dialing

Making calls with memory dialing

Dialing from standby

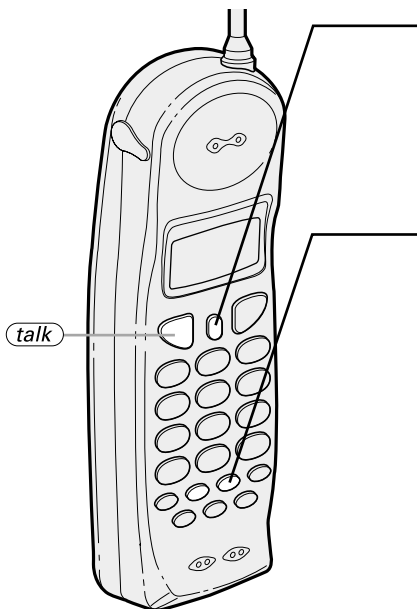

- 1** Press **(mem)**.
The handset displays your programmed memory locations.

```
1 UNIDEN CORP
2 JOHN DOE
3 MOM AND DAD
```

- 2** Press the **(▲ up)** and **(dn ▼)** keys to select the memory location you would like to dial.

For example if the **(dn ▼)** key is pressed once, the pointer moves down to the next memory location number.

```
2 JOHN DOE
3 MOM AND DAD
4▶
```

Or press the number keypad to select the memory location you would like to dial.

For example if you pressed 5 on the keypad, the display shows memory location number 5 with the pointer in that line.

```
5▶ JOHN SMITH
6 <Memory 6>
7
```

- 3** Press **(talk)**, "Talk" momentarily flashes on the display and the volume setting appears. Then the displayed number is dialed.

```
▶Talk-
0123456789012
```

Notes

- To cancel memory selection, press **(mem)** during memory dialing. The handset returns to standby.
- Whenever you are using a menu screen, you must press a key within 20 seconds or the phone will return to standby.

Memory dialing (continued)

Display a Programmed Number

Press **(mem)**, then use the **(#/▶)** and **(*/tone/◀)** keys to toggle between the name and the number displays.

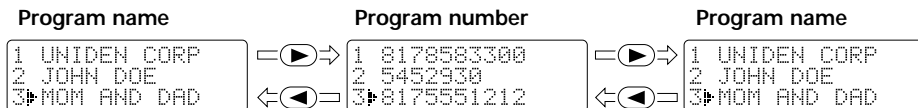

Note When the stored phone number has 15 or more digits, the first 14 digits of the phone number are displayed.

Dialing from talk mode

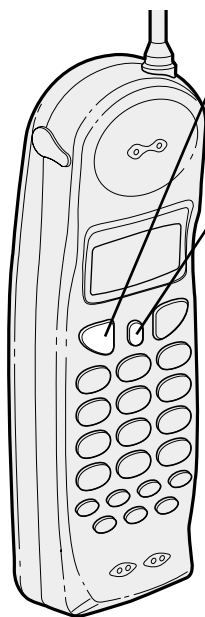

- 1 Press **(talk)**.
"Talk" and the volume setting appear on the display.



- 2 Press **(mem)**.

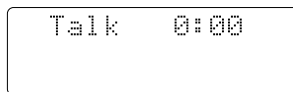

- 3 Press the number keypad to select the memory location of the desired phone number. The selected phone number is displayed. Then the number is dialed.

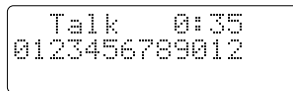

Note

Memory location 0 follows memory location 9.

Memory editing

Editing a stored name and/or phone number

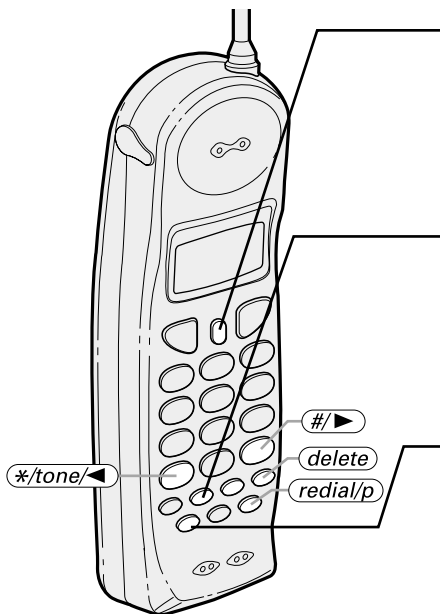

- 1** Press and hold **(mem)** until a tone sounds and "Memory Store" is displayed.

```
Memory Store
1▶UNIDEN CORP
2 JOHN DOE
```

- 2** Press the **(▲up)** or **(dn▼)** keys or number keypad to select the memory location you would like to edit.

```
Memory Store
1 UNIDEN CORP
2▶JOHN DOE
```

- 3** Press **(select)**. The following screen appears with the memory location number that you have selected in the display.

For example, if you selected memory location number 1, the display shows memory 1 selected.

```
▶Edit Memory 1
Delete Memory 1
Go Back
```

- 4** Press the **(▲up)** or **(dn▼)** key to select "Edit Memory", then press **(select)**. The following screen appears. The cursor flashes indicating that the display is ready for the name to be edited. When a name has not been stored, the cursor appears at the beginning of the second line.

```
Store Name
UNIDEN CORP█
```

- 5** Press **(▲up)**, **(dn▼)**, **(#/▶)**, **(*/tone/←)**, or **(delete)** to edit the name. (See page 20.) To edit only the phone number, skip this step.

- 6** Press **(select)**. The following screen appears. The cursor flashes indicating that the display is ready for the number to be edited.

```
Store Number
0178583330█
```

Memory editing (continued)

7 Use the number keypad, **(*/tone/◀)**, **(#/▶)**, **(redial/p)**, or **(delete)** key to edit the phone number. The phone number cannot exceed 16 digits. (See page 20.) When the phone number is not to be edited, skip this step.

8 Press **(select)**.
The handset beeps and displays the confirmation screen. The memory storage is complete.

For example if you store a name and number into memory location number 1, the display shows "Memory 1 stored".

```
Memory 1 Stored
```

After about 2 seconds, "Memory Store" is displayed.

```
Memory Store  
1▶UNIDEN CORP  
2▶JOHN DOE
```

9 Press **(mem)** to exit edit mode.

Display a Programmed Number

Use the **(#/▶)** and **(*/tone/◀)** keys to toggle between the names and the numbers display.

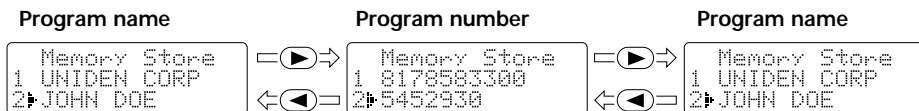

Memory erasing

Erasing a stored name and/or phone number

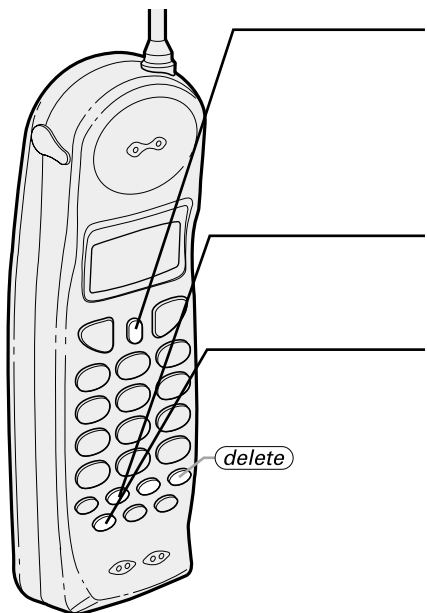

- 1** Press and hold **mem** until a tone sounds and "Memory Store" is displayed.

```
Memory Store
1 UNIDEN CORP
2 JOHN DOE
```

- 2** Press the **▲up** or **▼dn** keys or number keypad (0-9) to select the memory location you would like to erase.

- 3** Press **select** .
Example: Memory 2 selected

```
►Edit Memory 2
Delete Memory 2
Go Back
```

- 4** Press **▼dn** to move the pointer down to "Delete Memory" .

```
Edit Memory 2
►Delete Memory 2
Go Back
```

- 5** Press **select** . The following confirmation screen appears.

```
Delete Memory 2?
Yes
►No
```

- 6** Press **▲up** to move the pointer to "Yes" .

- 7** Press **select** or **delete** .
A tone sounds and the memory is deleted.
The following screen appears.

```
Memory 2 Deleted
```

- 8** After 2 seconds the display returns to the "Memory Store" screen.
You may select another number to delete (return to step 2).

```
Memory Store
1 UNIDEN CORP
2►
```

- 9** Press **mem** to return to standby.

Using the Page Feature

To locate the handset (while it's off the base)

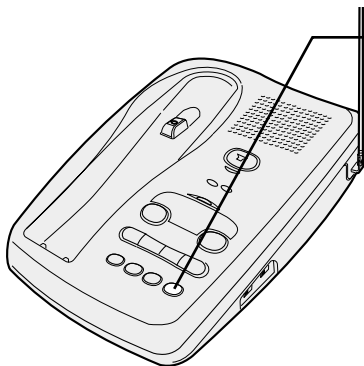

- 1** Press **page** on the base.
- 2** The handset beeps for 60 seconds.
- 3** Press any key except **talk** on the handset to cancel the page.

Caller ID Features

You must subscribe to the Caller ID service from your telephone company to use this feature.

When the telephone rings

- 1 When phone rings, the **status** LED blinks.
On the second ring, the display shows the caller's phone number, along with the date and time. The incoming call information is stored.
If the Caller ID service includes the caller's name, it appears on the display (up to 16 letters).

**The date and time received
and call count**
Caller's name
Caller's phone number

```
5/11 12:30PM 01
UNIDEN CORP
813-858-3300
```

Here are some typical displays:

**When the phone number and name data
are received**

```
5/11 12:30PM 01
UNIDEN CORP
817-858-3300
```

When a private number is received

```
5/11 12:30PM 01
UNIDEN CORP
Private Number
```

When a private name is received

```
5/11 12:30PM 01
Private Name
817-858-3300
```

When an unknown number is received

```
5/11 12:30PM 01
UNIDEN CORP
Unknown Number
```

When an unknown name is received

```
5/11 12:30PM 01
Unknown Name
817-858-3300
```

When invalid data is received

```
Incomplete Data
```

- 2 When the telephone is answered, the display changes to "Talk".

Notes

- If you answer a call before the Caller ID message is received (Example: before the second ring), the Caller ID message will not appear.
- When the call is received via a telephone company that does not offer Caller ID service, the caller's phone number and name do not appear.
(This includes international calls.)
- When the call is via a private branch exchange (PBX), the caller's phone number and name may not appear.
- Data errors appear as "■".

```
5/11 12:30PM 01
UNI■EN CORP
813-8■■-3300
```

Viewing the Caller ID Message list

The Caller ID list stores information for up to 30 incoming calls - even unanswered calls.

Note If a call comes in via a telephone system that does not offer Caller ID service, no information is stored.

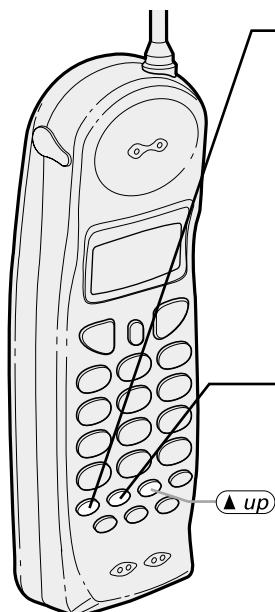

- 1 Press **call id**. The summary screen appears. When there are new messages you have received, "New" and the number of calls are displayed. The summary screen shows how many new calls are stored, along with the total of new and old calls stored in the list.

```
New :01
Total:02
```

- 2 Press **dn** to display the latest Caller ID message.

```
5/17 12:30PM 03
UNIDEN CORP
817-858-3300
```

- 3 Press **dn** to see the next message. Or press **up** to see the previous message.

- 4 Press **call id** to return to standby.

Long Distance call settings and cancellation

Pressing **1** while the incoming call information is displayed (in step 2) will set or cancel a long distance call. The prefix "1-" will be displayed at the beginning of the phone number when a long distance call is set.

Pressing **1** again will cancel the long distance call setting.

```
5/17 12:30PM 03
UNIDEN CORP
1-817-858-3300
```

Notes

- "End" appears when you have reviewed all messages in the Caller ID list.
- Each message can be up to 16 characters for the phone number and the name.

Deleting information from the Caller ID list

The EXAI 7980 stores up to 30 Caller ID messages. If more new calls are received, messages stored in the list are deleted beginning with the oldest message in the list. Data can also be deleted manually.

Deleting a Caller ID message

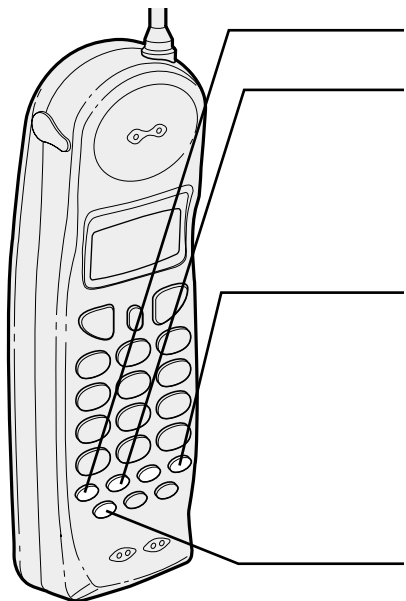

- 1 Press **call id**.
- 2 Press **▲ up** or **dn ▼** to select the message that you would like to delete. (See page 28.)

```
5/17 12:30PM 03
UNIDEN CORP
817-858-3300
```

- 3 Press **delete**, while the summary screen is displayed.
- 4 Press **▲ up** or **dn ▼** to select "Yes" or "No".

```
Delete Message ?
▶ Yes
No
```

- 5 Press **select** or **delete**.

When the pointer is at "Yes":

A tone sounds and the next Caller ID message is displayed.

When the pointer is at "No":

The display returns to the Caller ID display.

Notes

- While using the "Delete Message ?" screen, if no key is pressed for more than 20 seconds, an error tone sounds and the telephone returns to standby.
- If you get an incoming call, the deleting operation is canceled and the telephone returns to standby so you can answer the call.

Deleting all Caller ID names/numbers

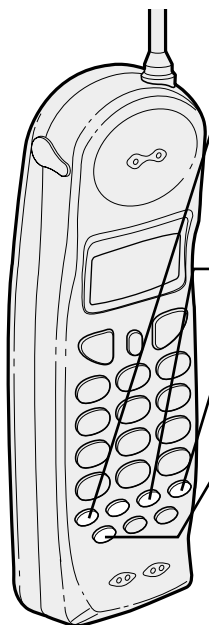

1 Press **(call id)**.

```
New :01
Total:02
```

2 Press **(delete)**, while the summary screen is displayed.

3 Press **(▲ up)** or **(dn ▼)** to select "Yes" or "No".

```
Delete All ?
Yes
#No
```

4 Press **(select)** or **(delete)**.

When the pointer is at "Yes":

A tone sounds and all stored Caller ID messages are deleted.

```
Total:00
```

When the pointer is at "No":

The display returns to the summary screen.

```
New :01
Total:02
```

Notes

- While using the "Delete All ?" screen, if no key is pressed for more than 20 seconds, an error tone sounds and the telephone returns to standby.
- If you get an incoming call, the deleting operation is canceled and the telephone returns to standby so you can answer the call.

Using the Caller ID list

Calling a party from the Caller ID list

You can place a call from the Caller ID list.
The EXAI 7980 stores up to 30 messages.

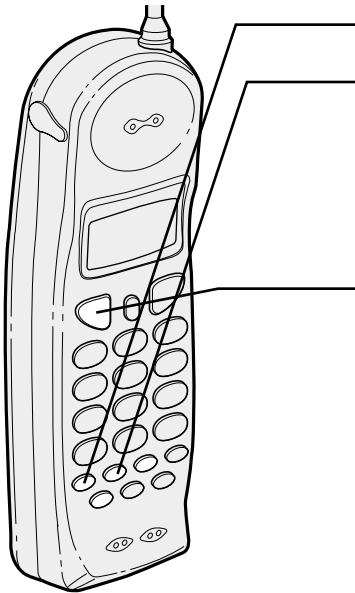

- 1 Press **call id**.
- 2 Press **▲ up** or **▼ dn** to select the phone number that you want to dial. (See page 28.)

```
5/17 12:30PM 03  
UNIDEN CORP  
817-858-3300
```

- 3 Press **talk**.

```
Talk  
8178583300
```

The displayed phone number dials automatically.

Long Distance calls

Pressing **1** while the incoming call information is displayed (in step 2) will place a "1" in front of the number for long distance calling. Press **1** again to remove the "1".

Notes

- When a long distance call has been set, "1" appears in the display.
- You cannot make a call from the Caller ID list, if your EXAI 7980 is connected to private branch exchange (PBX).

Storing Caller ID messages in Memory

Messages shown in the Caller ID list can be stored for memory dialing. Using the incoming call information (i.e., Caller ID list), the phone number of the party on the Caller ID list can be stored in memory dialing.

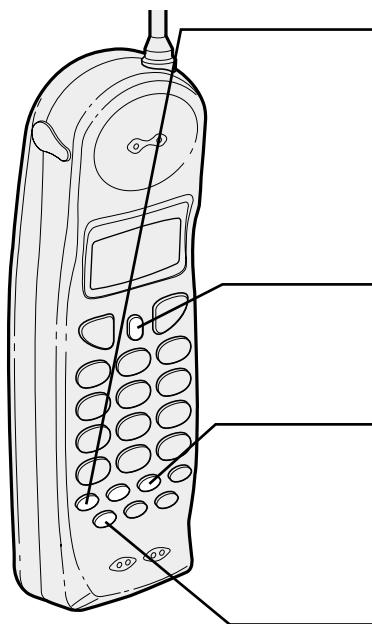

1 Press **(call id)**.

2 Display the phone number to be stored from the Caller ID list. (See page 28.)

```
5/17 12:30PM 03
UNIDEN CORP
817-858-3300
```

3 Press **(mem)**.

```
Select Location
1: UNIDEN CORP
2: JONE DOE
```

4 Press **(▲ up)** or **(▼ dn)** to select the memory location where you wish to store the name and number from the Caller ID list.

Press the number keypad (**(0)** to **(9)**) and select the number (0-9).

5 Press **(select)**.

A tone will sound. The number is stored in memory, and the display returns to the Caller ID list.

```
5/17 12:30PM 03
UNIDEN CORP
817-858-3300
```

Notes

- If a message has already been stored in the selected memory location, a verification screen is displayed. Press **(▲ up)** to select "Yes". Press **(select)** to overwrite. The display returns to the Caller ID list.
- You can not store a Caller ID message if no phone number appears in the message.
- If no key is pressed for more than 20 seconds, an error tone sounds and the telephone returns to the standby mode.
- If there is an incoming call or page, memory storage is canceled and the telephone is set to the incoming call or page.

```
Replace Memory ?
Yes
#No
```

Using "Caller ID with call waiting" service

"Caller ID" and "Call waiting" are separate services. CIDCW (Caller ID on Call Waiting) performs the same as regular Caller ID on a call waiting number. You must subscribe to the "Caller ID with call waiting (CIDCW)" service from your telephone company before you can use the following features.

The "Call waiting" service can also be used independently. Please contact your telephone company for details.

When a new incoming call arrives during your current telephone call, the phone number appears. (The name of the new caller is displayed, depending upon the telephone service.)

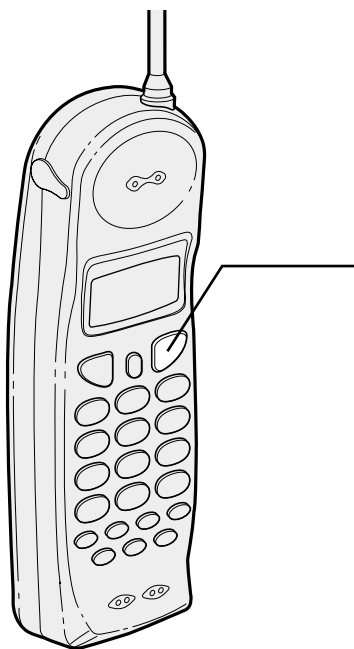

- 1 When a new incoming call arrives during your current telephone call, the phone number and the name of the caller is displayed.

```
Talk 10:30  
UNIDEN CORP  
817-858-3300
```

- 2 Press **flash** .
You will be able to talk with the person that has just called. The person with whom you were talking will be put on hold.
- 3 To return to the first caller, press **flash** again.

Using the answering machine

Setting the clock

The answering machine's clock starts when the AC adapter cord is plugged in.

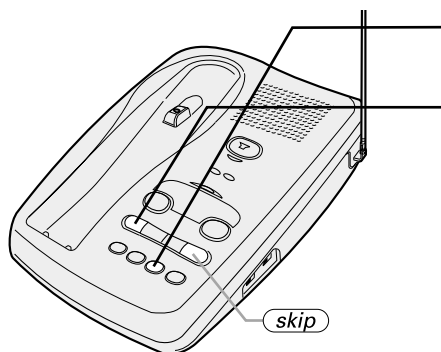

- 1** Press **(clock)** until you hear the long beep.
- 2** First set the day by pressing **(repeat)** or **(skip)**.
When the number appears on the LED display, press **(clock)**.
The unit announces the day currently selected.
- 3** Next set the hour by pressing **(repeat)** or **(skip)**. When the correct numbers appear in the LED display, press **(clock)**.
- 4** Then set the Minute by pressing **(repeat)** or **(skip)**. When the correct numbers appear in the LED display, press **(clock)**.
- 5** Lastly, set AM/PM by pressing **(repeat)** or **(skip)**. The LED display will show A (AM) and P (PM) in turn. At the correct one, press **(clock)**.
You will hear a long beep.

Then you will hear the new day and time.

Notes

- You can hear the current time set by pressing **(clock)**.
- If a call comes in during clock setting, start over after the call.
- In case of power interruption, the clock stops. You must reprogram the time once power is restored.
- If you begin to set the clock, and you pause for more than two minutes, the unit returns to standby.

Recording the greeting

You can record a personalized greeting or use the pre-recorded message.

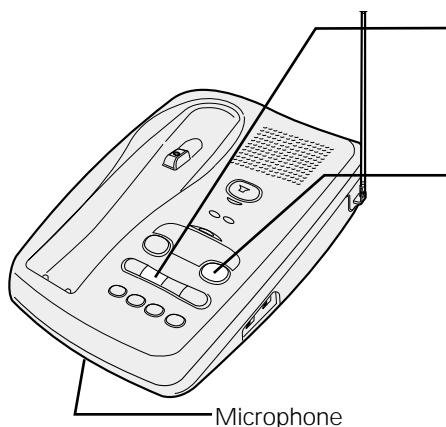

- 1** Press and hold **greeting** on the base until you hear the long beep. Then, begin speaking towards the microphone.
- 2** When you finish speaking, press **greeting** or **play/stop**. The greeting you just recorded will automatically be played back.

Note

The base microphone is located under the phone. Position yourself as near to the base as possible.

Changing the greeting

You can change from the pre-recorded greeting to your own recorded greeting or vice versa.

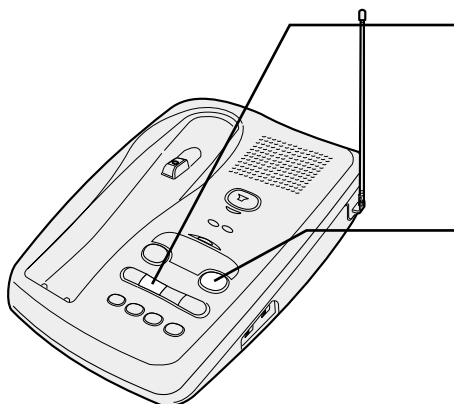

- 1** Press **greeting** on the base unit. You will hear the currently selected greeting.
- 2** Press **greeting** while the unit is playing the greeting.
- 3** Wait until the entire greeting is played back, or press **play/stop**. Now, the greeting is changed.

Turning the answering machine on and off

Check the LED display to see if the answering machine is on or off. If the LED display is on, the unit is on and ready to take messages. If the LED display is off, it will not take messages.

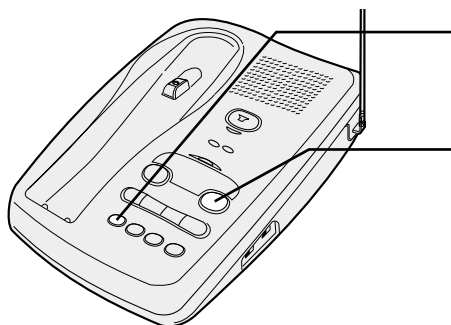

- 1** Press **answer** to change the status from on to off. The LED display indicates the change.
- 2** When the unit is turned on, it initializes by playing the greeting. If you want to stop playing, press **play/stop**.

Setting the number of rings

Choose one of three settings by sliding the **RING TIME** switch on the base unit to one of the following positions:

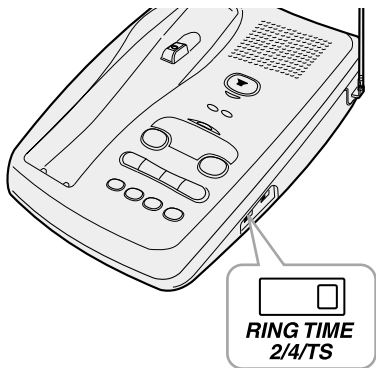

2 : 2 times

4 : 4 times

TS : In the **TS** (toll saver) position, if you have new messages, the answering system answers after two rings. If there are no new messages, the system answers after four rings. This way, when you call long distance to check your messages, and have no messages, you can hang up after the second ring to save a charge.

Setting maximum recording time for incoming messages

You can select the maximum recording time by sliding the **REC TIME** switch on the base unit to one of the following positions:

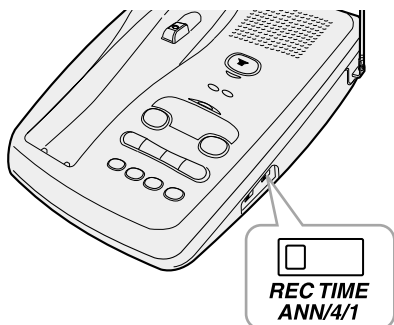

1 : 1 minute

4 : 4 minutes

ANN : Announce only

Note

If you set the switch to **ANN**, a prerecorded greeting plays, and no message will be accepted.

Playing recorded messages

You can listen to the message at the base unit.

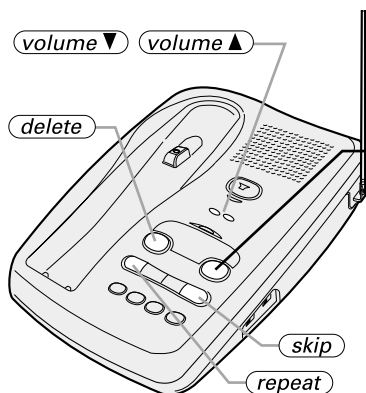

- 1** The number on the display blinks to indicate that there are new messages received.
- 2** Press **play/stop** to hear the messages. They will be played in the order they were received.

To stop playback, press **play/stop** any time.

To repeat the message, press **repeat**. To repeat the previous message, press **repeat** within 2 seconds after the current message has started. If you press after 2 seconds, the current message is repeated from the beginning.

To go backward and repeat a message you choose, press and hold **repeat** until your desired message number appears on the display.

To skip to the next message, press **skip**.

To go forward, press and hold **skip** until your desired message number appears on the display.

To adjust the speaker volume, press **volume ▼** / **volume ▲**. The volume level is displayed by a figure from 1 to 10.

Deleting recorded messages

To delete individual messages, press **(delete)** during playback, immediately after, or before the next message begins. You will hear a confirmation tone when the deletion is completed.

To delete all messages, first, make sure all new messages are played. Then press and hold **(delete)** at the base until you hear a long beep.

Notes

- If there are messages that you have not listened to when you are deleting all messages, you will hear several short beeps and the messages will not be deleted. This is to protect you from accidentally erasing messages you have not yet listened to.
- To maintain maximum available record time, it is a good idea to delete the old messages.

Screening incoming calls

You can screen calls using the base unit.

- 1** After the answering machine starts, the base speaker lets you hear the caller as the machine records the message.
- 2** To answer the call immediately, follow the directions below. The answering machine will disconnect automatically.

AT THE HANDSET

Auto Talk on:

When the handset is on the base unit: Simply pick up the handset

When the handset is away from the base unit: Press **(talk)**

Auto Talk off:

When the handset is on the base: Pick up the handset and press **(talk)**

AT THE BASE

Press **(speaker)**

Note

If the message portion is 2 seconds or less, it will not be retained as a message.

Leaving a voice memo

You can record a memo by using the base unit, as a reminder to yourself or as a message for someone else in the household. A memo is stored and played back like any other incoming message, and the LED display will light to indicate that a message has been received.

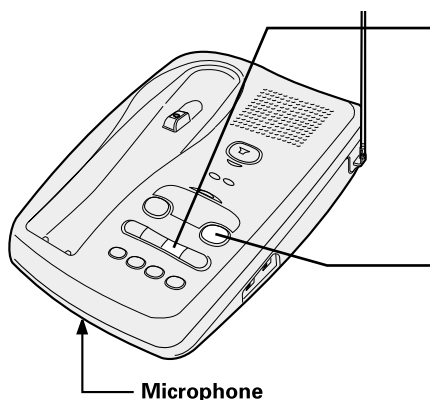

- 1** Press and hold **voice memo** for approximately 1 second.
- 2** After a long beep, turn to the microphone and begin speaking. Be sure to keep within 10 inches of the microphone while recording.
- 3** When you have finished the memo, press **voice memo** again, or press **play/stop**.

Note

If a call comes in during the memo recording, the unit will stop recording automatically and the ringer will sound. You will need to start over after the call. The memo must be at least 2 seconds long.

Recording a phone conversation (2-way REC)

You can record a telephone conversation that is already in progress. The conversation is stored and played back like an incoming message.

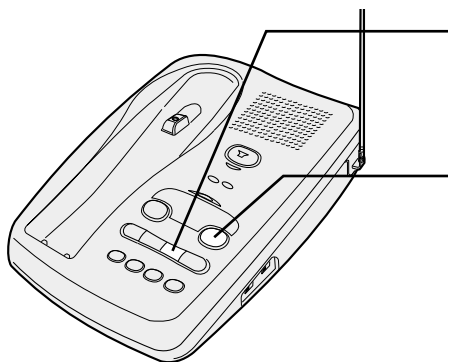

- 1** During the conversation, press and hold **voice memo** on the base unit approximately 1 second. Recording starts automatically.
- 2** To stop recording, return the handset to the base and press **voice memo** or **play/stop** on the base unit.

Notes

- The recorded conversation must be at least 2 seconds long, or it will be automatically deleted.
- The telephone beeps intermittently to alert the parties that the conversation is being recorded.
- You cannot use 2-way REC when you using the speakerphone.

Selecting a PIN code

To play your messages from a remote location, you will need to enter a two-digit Personal Identification Number (PIN) code (00-99). To select a PIN, perform the following steps:

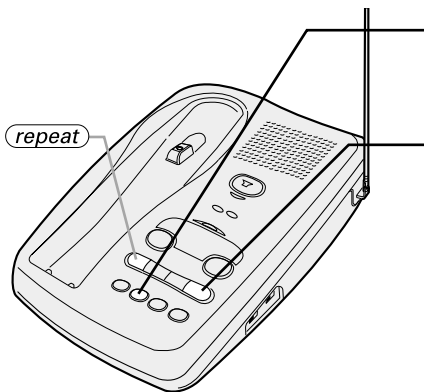

- 1** On the base, press and hold **(pin)**. A beep sounds, and the LED displays **00**.
- 2** Press **(skip)** or **(repeat)** to select the first number. When the desired number appears in the display, press **(pin)**.
- 3** Press **(skip)** or **(repeat)** to select the second number. When the desired number appears in the display, press **(pin)**.

Note

If you don't select a PIN code within two minutes, the system returns to standby.

Remote access away from home

You can operate your answering system from a remote location using any touch-tone telephone. Use this function to check for recorded messages, to play or delete messages, even to record a new outgoing message, and to monitor sounds in the room.

- 1 Call your telephone number.
- 2 While the greeting message plays, press **#** and your PIN code. If the answering machine is off, let it ring 10 times until the greeting message plays. Then, press **#** and your PIN code.
- 3 The answering system announces the time and day stamp and the number of messages stored in memory. Then the Message playback automatically begins.
- 4 You may continue to listen to your messages or you may select a command from the following chart:

Command	Function
# then 1	Repeat
# then 2	Playing your messages
# then 3	Skipping a message
# then 4	Deleting a message
# then 5	Stop message playback
# then 6	Answering system on
# then 7	Voice memo record/stop (up to 4 minute recording time)
# then 8	Greeting message record/stop
# then 9	Answering system off
# then *	Room monitor

- 5 After all of your messages have played, or the playback time exceeds 4 minutes, you will hear intermittent tones indicating that the system is in the command waiting mode. You may enter another command at this time from the chart above.
- 6 When you are finished, hang up to exit the system. The answering system automatically returns to standby.

Notes

- During the remote operation,  displays on the base.
- You must enter a command within 15 seconds of entering the command waiting mode or the answering system automatically hangs up and returns to standby.
- The system will only play back messages for four minutes and then it returns to the command waiting mode. To continue playing your message, press **#** then **2** again within 15 seconds

Remote room monitor

You can call your answering system from any touch-tone phone and monitor sounds in the room where your base unit is installed.

- 1** Call your telephone number.
- 2** During the outgoing message playback, press **#** followed by your PIN code.
- 3** The answering system begins announcing the time and day stamp.
- 4** Press **#** then ***** while the system announces the time and day stamp.

You hear sounds in the room where your phone is installed. After 15 seconds, the answering system returns to the command waiting mode.

- 5** Press **#** then ***** to monitor the room for another 15 seconds. Or select another remote function. Or hang up to exit the system. The answering system automatically returns to standby.

Turn on the answering machine remotely

If you have forgotten to turn on your answering machine, you can turn it on remotely from any touch-tone telephone.

- 1** Call your telephone number.
- 2** Wait ten rings until the machine answers.
You hear a beep.
- 3** Enter your PIN code.
The answering system begins to announce the time and day stamp.
- 4** Press **#** then 5 to stop the announcement.
- 5** Press **#** then 6 to turn the answering system on.
- 6** Hang up the phone and subsequent calls will be answered by the machine.

Additional information

3-way conversation

The Uniden EXAI 7980 permits 3-way conversations between the handset, base, and outside line.

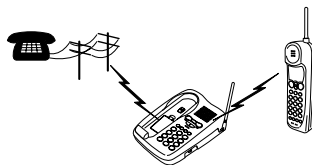

When speaking on the handset

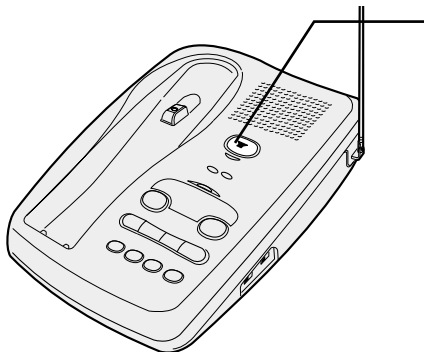

- 1 Press **speaker** on the base to join the 3-way conversation.
- 2 Press **speaker** on the base to hang up. The handset will still be connected to the outside call.

Note

- Pressing **speaker** on the base while dialing with the handset sets the 3-way conversation mode. Dialing is not affected.

When speaking on the base

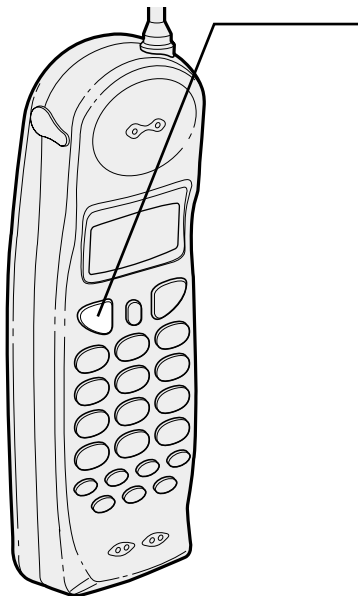

- 1 Press **talk** on the handset to join the 3-way conversation.
- 2 Press **talk** on the handset to hang up. The base will still be connected to the outside call.

Changing the digital security code

The digital security code is an identification code used to connect the handset and the base unit. Normally, setting the code is not necessary.

The first time you charge your handset, the security code is automatically set. (See page 4.)

In the rare situation that you suspect another cordless telephone is using the same security code, you can change the code.

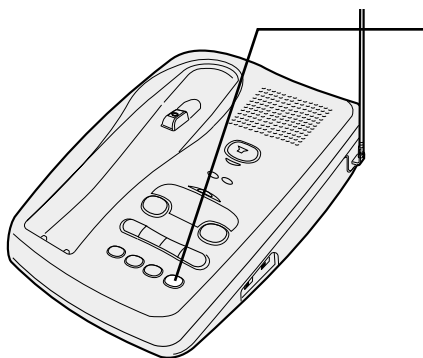

- 1** Place the handset on the base unit. Press **page**. The handset beeps.
- 2** Remove the handset from the base unit.
- 3** Place the handset on the base unit. Leave the handset on the base for at least 3 seconds. A new random security code is set.

Note

If the handset battery pack is completely discharged or the battery pack removed, the digital security code will be lost. If this happens, a new security code is set automatically the next time the battery pack is charged.

Mounting the base unit on a wall

[Standard wall plate mounting]

This phone can be mounted on any standard telephone wall plate.

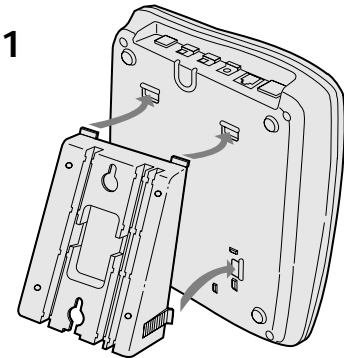

- 1 Snap the wall mount adapter into the notches on the base.

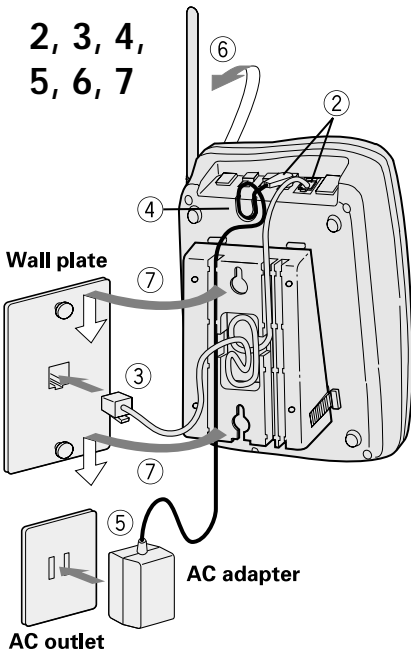

- 2 Plug the telephone line cord to the **TEL LINE** jack and the AC adapter to the **DC IN 9V** jack.

- 3 Plug the telephone line cord into the telephone outlet.

- 4 Wrap the AC adapter cord inside the molded wiring channel. Then wrap the cord around the strain relief notch.

- 5 Plug the AC adapter into a standard 120VAC wall outlet.

Note Use only the Uniden AC adapter supplied with this phone.

- 6 Raise the antenna to a vertical position.

- 7 Align the mounting slots on the base with the mounting posts on the wall. Push in and down until the phone is firmly seated.

Additional information (continued)

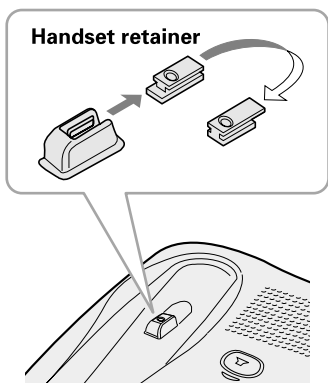

- 8 On the base unit, pull the handset retainer out of the slot. Rotate it clockwise 180 degrees.
- 9 Flip the retainer from front to back. Slide it back into the slot so that the lip of the retainer is up and the oval is down. The retainer holds the handset in place.

[Direct wall plate mounting]

If you don't have a standard wall plate, you can mount your phone directly to the wall. Before doing this, consider the following:

- Avoid electrical cables, pipes, or other items behind the mounting location. That could cause a hazard when inserting screws into the wall.
- Try to mount your phone within 10 - 15 feet of a working phone jack to avoid excessive cord lengths.
- Make sure the wall material is capable of supporting the weight of the base and handset.

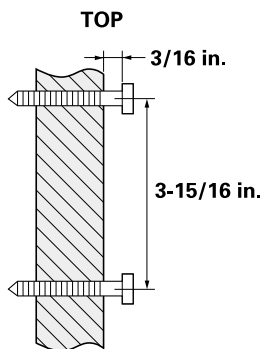

- 1 Insert two mounting screws into the wall, (with their appropriate anchoring device), $3-15/16$ inches apart. Allow about $3/16$ of an inch between the wall and screwheads for mounting the phone.
- 2 Refer to steps 1 through 9 on pages 47 to 48 to mount the telephone.

Installing the beltclip

To attach the beltclip

Insert the beltclip into the holes on each side of the handset. Press down until it clicks.

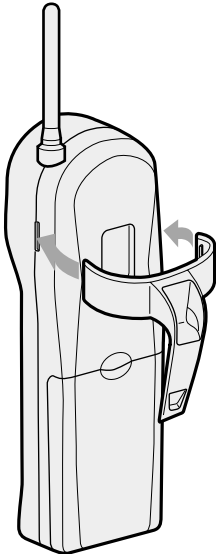

To remove the beltclip

Pull both sides of the beltclip to release the tabs from the holes.

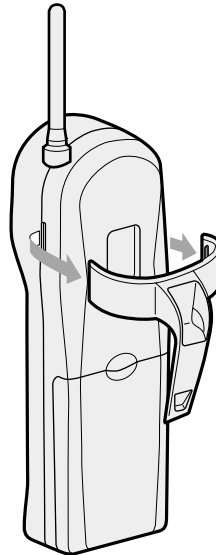

Headset installation

Your phone may be used with an optional headset, the Uniden HS910. To use this feature, simply plug the headset plug into the headset jack. Your phone is ready for hands-free conversation.

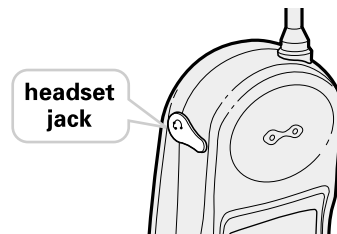

Note

Use of headsets other than the HS910 may void warranty.

Note on power sources

Battery replacement and handling

When the operating time becomes short, even after a battery is recharged, please replace the battery.

With normal usage, your battery should last about one year.

Please contact your place of purchase for a replacement battery, or contact the Uniden Parts Department for genuine Uniden parts.

Power Failure

During the period that the power is off, you will not be able to make or receive calls with the telephone.

RECYCLING NICKEL-CADMIUM BATTERIES

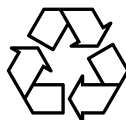

NICKEL-CADMIUM BATTERIES MUST BE DISPOSED OF PROPERLY.

Ni-Cd

Nickel-cadmium cells are used in the battery pack. Please take your used nickel-cadmium battery packs to a store that recycles nickel-cadmium batteries.

Caution

- Use the specified battery pack.
- Do not remove the battery from the handset to charge it.
- Never throw the battery into a fire, disassemble it, or heat it.
- Do not remove or damage the battery casing.

Maintenance

When slightly dirty

Wipe with a soft, dry cloth.

When very dirty

Wipe with a soft cloth that has been dampened with a mild dishwashing detergent. Dry with a dry cloth.

When the charging terminals become dirty

Wipe with a dry cloth or pencil eraser, if necessary.

Caution

Do not use paint thinner, benzene, alcohol, or other chemical products. Doing so may discolor the surface of the telephone and damage the finish.

Troubleshooting

If your phone is not performing to your expectations, please try these simple steps first.

Symptom	Suggestion
The status light won't come on when the handset is placed in the base unit.	<ul style="list-style-type: none"> • Make sure the AC adapter is plugged into the base unit and wall outlet. • Make sure the handset is properly seated in the base unit. • Make sure the charging contacts on the handset and base unit are clean.
The audio sounds weak and/or scratchy.	<ul style="list-style-type: none"> • Make sure that the base unit antenna is in a vertical position. • Move the handset and or base unit to a different location away from metal objects or appliances and try again. • Press (chan) to help eliminate background noise. • Make sure that you are not too far from the base.
Can't make or receive calls	<ul style="list-style-type: none"> • Check both ends of the base unit telephone line cord. • Make sure the AC adapter is plugged into the base unit and wall outlet. • Disconnect the AC adapter for a few minutes, then reconnect it. • Reset the digital security code (See page 46). • Make sure (talk) is pressed.
The handset doesn't ring or receive a page.	<ul style="list-style-type: none"> • The battery pack may be weak. Charge the battery on the base unit for 12-15 hours. • The handset may be too far away from the base unit. • Place the base unit away from appliances or metal objects. • Reset the digital security code (See page 46).
The Caller ID disappears.	<ul style="list-style-type: none"> • The handset was picked up before the second ring.
The Caller ID does not display.	<ul style="list-style-type: none"> • The call was placed through a switch board. • Call your local telephone company to verify your Caller ID service is current.

Additional information (continued)

Symptom	Suggestion
The answering system does not work.	<ul style="list-style-type: none">• Make sure the base unit is plugged in.• Make sure the answering system is turned on.• Press (<u>reset</u>) after an AC line spike.
The answering system does not answer calls.	<ul style="list-style-type: none">• Select REC TIME switch to either the one minute or four minute option.• The memory may be full. Delete some or all of the saved messages.
Messages are incomplete.	<ul style="list-style-type: none">• The incoming messages may be too long. Remind callers to leave a brief message.• The memory may be full. Delete some or all of the saved messages.
After a power failure, the greeting is deleted.	<ul style="list-style-type: none">• Record your personal greeting again. The prerecorded messages should remain.
No sound on the base unit speaker during call monitoring or message playback.	<ul style="list-style-type: none">• Adjust the speaker volume on the base unit.

At Uniden, we'll take care of you!

If you need any assistance with this product, please call our Customer Hotline at

1-800-297-1023

PLEASE DO NOT RETURN THIS PRODUCT TO THE PLACE OF PURCHASE.

Our Uniden representatives will be happy to help you with any matters regarding the operation of this unit, available accessories, or any other related matters.

Thank you for purchasing a Uniden product.
Hours: M-F 7:00 AM to 7:00 PM CST.

Index

0 - 9

3-way conversation.....45

A

Answering machine

Changing the greeting35

Deleting recorded messages.....39

Leaving a voice memo.....40

Playing a recorded messages.....38

Recording a phone conversation ...41

Recording the greeting35

Remote access away from home..43

Remote room monitor44

Screening incoming calls39

Selecting a PIN code.....42

Setting the clock34

Setting the number of rings.....36

Setting the maximum recording time for the incoming message.....37

Turning the answering machine on and off.....36

Area code12

B

Base ringer switch.....18

Base speaker volume18

Battery pack

Preparing and charging9

Replacement and handling50

C

Caller ID service

Calling from the Caller ID list.....31

Deleting the Caller ID list.....29

Storing the data of the

Caller ID list to Memory.....32

Viewing Caller ID message list.....28

Caller ID with Call Waiting33

Channel button13

Connection7

D

Dialing mode.....8

Digital security code4,46

E, F, G, H

Editing a stored name and/or

phone number23

Erasing a stored name and/or

phone number25

Handset earpiece volume.....17

Headset installation49

I, J, K, L

Installing the beltclip.....49

M, N

Maintenance50

Making calls

Dialing from standby.....13

Dialing from talk mode.....14

Redialing15

Making calls with memory dialing.....21

Mounting the base unit on a wall.....47

O, P, Q

Package contents5

R

Receiving calls

Receiving a call from the base.....18

Receiving a call from the handset 16

Handset ringer tone.....17

S

Setting Caller ID options.....11

Setup

Base unit.....6

Handset.....9

Storing phone numbers and names19

T

Troubleshooting51

U, V, W, X, Y, Z

Using "Caller ID with Call Waiting" service33

Uniden America Corporation

4700 Amon Carter Boulevard
Fort Worth, TX 76155

Covered under one or more of the following U.S. patents:

4,511,761 4,523,058 4,595,795
4,797,916 5,426,690

Printed in China
UCZZ01271BZ